

Easy One Touch 5

Cupholder Mount • Porte-gobelet • Supporto per portabicchieri •
Getränkhalterhalterung • Soporte para portavasos

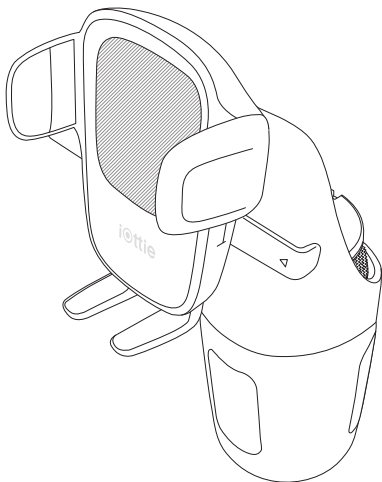

Manual • Guide • Manuale • Handbuch • Manual



iottie

Getting Started

For optimal mounting, please follow the detailed instructions within this manual when using the Easy One Touch 5. iOttie is not liable for possible damages due to product misuse.

Critical Information

- Mount should be aligned so that all 3 spacers contact the inner wall of the cup holder.
- Twist dial to extend spacers so they securely contact the inner wall of the cup holder.

Specifications

ITEM	SPECIFICATIONS
DEPTH	3.4"
WIDTH	2.75"
HEIGHT	7.2"
WEIGHT	7 oz

! Top half of mount rotates 90 degrees for optimal viewing.

! Mount rotates 360 degrees for optimal viewing angles.

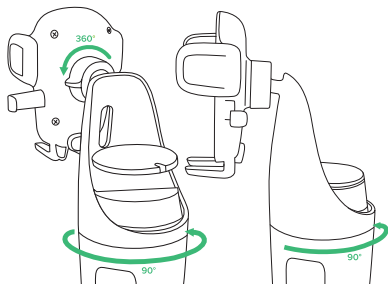

At a Glance

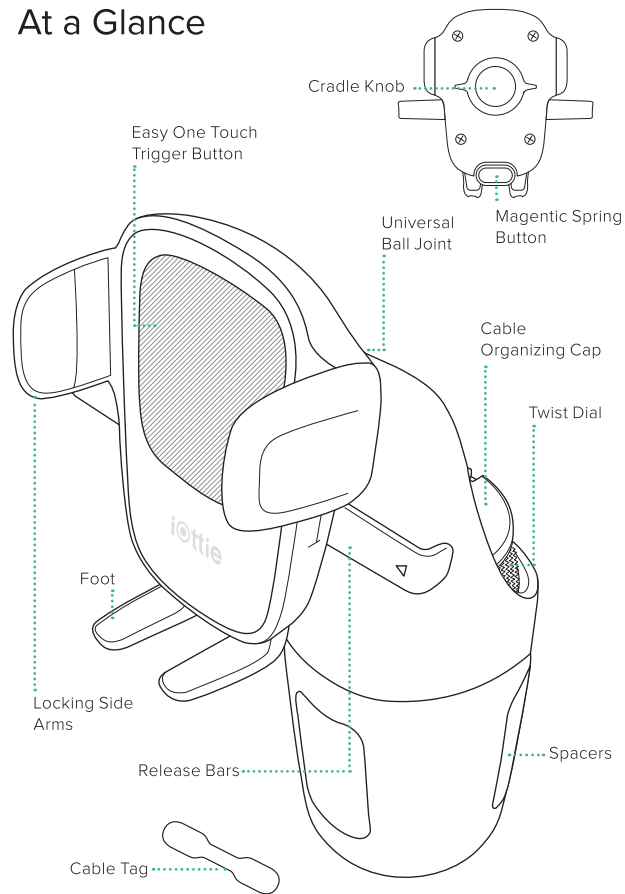

Using the Easy One Touch Mechanism

The Easy One Touch lock and release mechanism makes it simple to mount & retrieve smartphones in seconds.

Mounting

1. Press the locking side arms in.

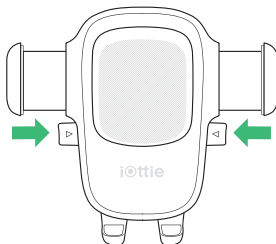

2. Press your device against the Easy One Touch trigger button. The mount's arms will automatically close on contact and hold the device during the driving journey.

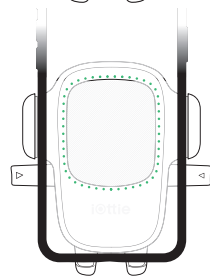

Releasing

Press the locking side arms with one hand and retrieve the device.

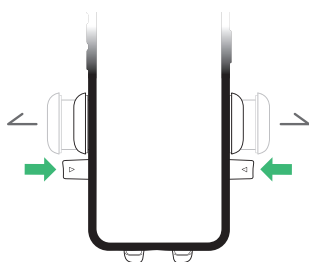

Adjusting the Mount



1. Cradle Knob

When mounting in landscape mode, loosen to rotate the Cradle. Tighten to lock in desired position.

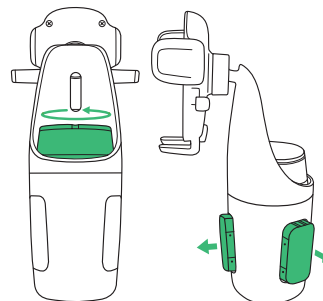

3. Twist Dial

Twist Dial to ensure spacers are secure in the cup holder walls.

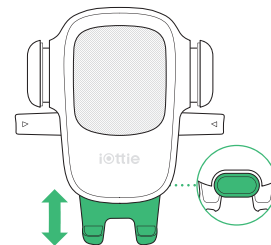

2. Foot Button

Located at the back of Cradle. Push the button to re-position mounts foot. The Foot can be adjusted up and down to fit any size phone.

! Magnetic Cord Organizer to keep your cord organized and out of the way.

A

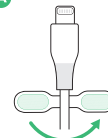

B

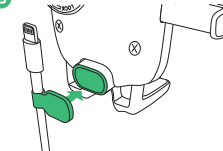

Commencer

Pour un montage optimal, veuillez suivre les instructions détaillées de ce manuel lors de l'utilisation du Easy One Touch 5. iOttie n'est pas responsable des dommages éventuels liés à une mauvaise utilisation du produit.

Information cruciales

- Le support doit être aligné de façon à ce que les 3 entretoises entrent en contact avec la paroi intérieure du porte-gobelet.
- Tourner le cadran pour prolonger les entretoises afin qu'elles entrent en contact avec les parois intérieures du porte-gobelet.

Spécifications

OBJET	SPÉCIFICATIONS
PROFONDEUR	8.6 cm
LARGEUR	7 cm
HAUTEUR	18.3 cm
POIDS	198 g

- ! La moitié supérieure du support pivote de 90 degrés pour une visualisation optimale.
- ! L'axe pivote à 360° pour une visualisation optimale des angles.

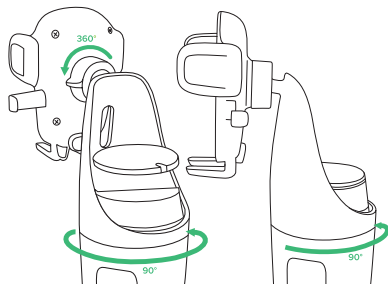

Aperçu

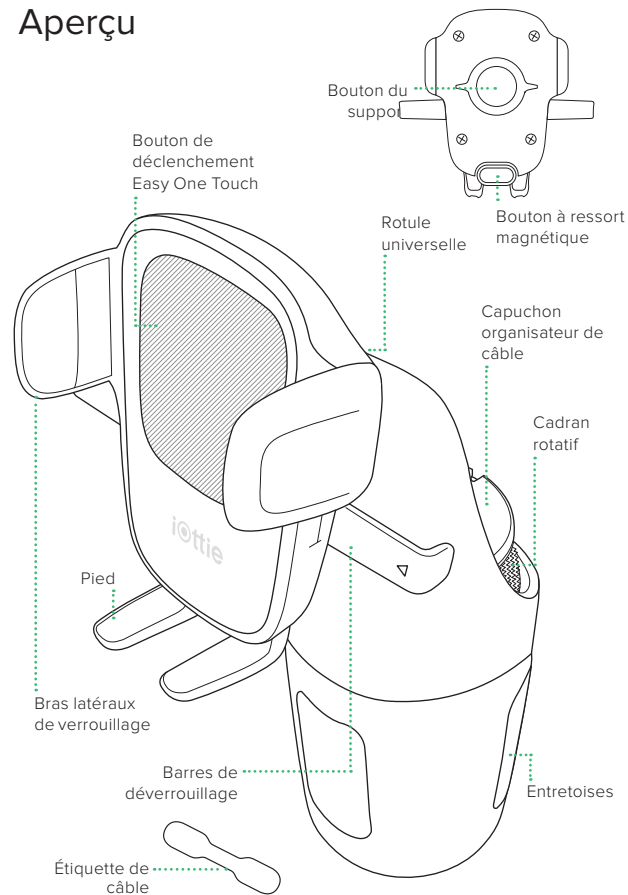

Utilisation du mécanisme Easy One Touch

Le mécanisme de verrouillage et de dégagement Easy One Touch facilite le montage et le retrait rapide des smartphones.

Montage

1. Appuyez sur les bras de verrouillage latéraux.

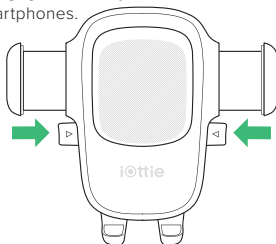

2. Appuyez votre appareil contre le bouton d'enclenchement Easy One Touch. Les bras de montage se fermeront automatiquement au contact et maintiendront l'appareil au cours de la conduite.

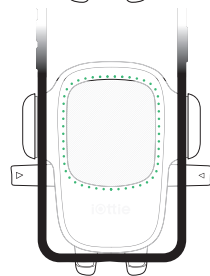

Libération

Appuyez sur les bras de verrouillages latéraux avec une main et récupérez l'appareil.

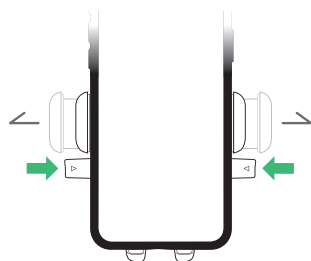

Ajustement de l'assemblage



1. Vis de support

Lors du montage en mode paysage, relâchez pour faire pivoter le support. Resserrer pour verrouiller dans la position désirée.

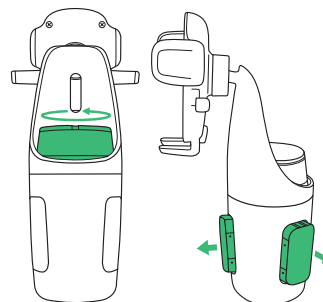

3. Cadran rotatif

Tourner le cadran pour s'assurer que les entretoises sont bien fixées dans les parois du porte-gobelet.

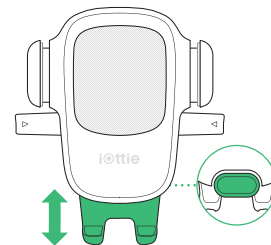

2. Bouton de pied.

Situé à l'arrière du Support. Appuyez sur le bouton pour repositionner le pied du support. Le pied peut être ajusté de haut en bas pour s'adapter à n'importe quel téléphone.

! Organisateur de câble magnétique pour garder votre câble de façon organisée et à l'écart.

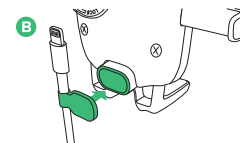
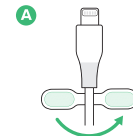

Iniziamo

Per un montaggio ottimale, seguire le istruzioni dettagliate contenute in questo manuale quando si utilizza Easy One Touch 5. iOttie non è responsabile per eventuali danni dovuti all'uso improprio del prodotto.

Informazioni cruciali

- El soporte debe estar alineado de manera que los 3 espaciadores entren en contacto con la pared interna del sujetador.
- Ruotare il quadrante per estendere i distanziatori in modo che entrino in contatto con le pareti interne del portabevande.

Specifiche

OGGETTO	SPECIFICAZIONI
PROFONDITÀ	8.6 cm
LARGHEZZA	7 cm
ALTEZZA	18.3 cm
PESO	198 g

! La parte superiore del supporto ruota di 90° gradi per un'ottimale visualizzazione.

! Il supporto ruota 360° per angoli di visione ottimali.

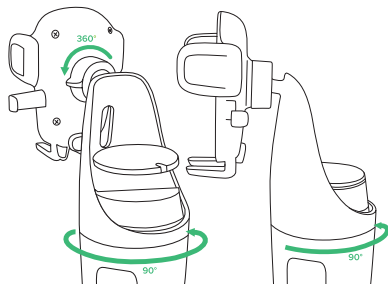

A prima vista

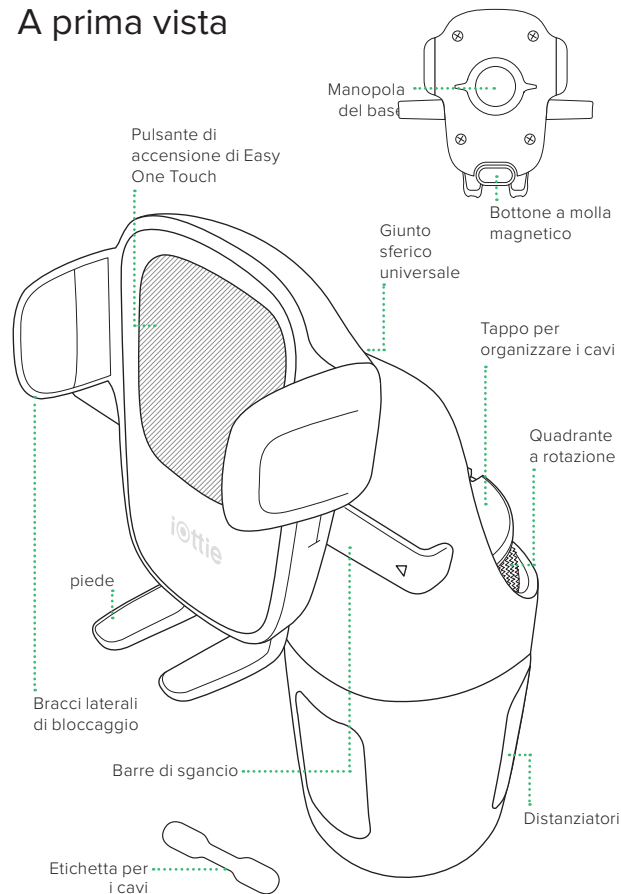

Utilizzo del meccanismo Easy One Touch

Il meccanismo di blocco e rilascio Easy One Touch semplifica il montaggio e il recupero degli smartphone in pochi secondi.

Il montaggio

1. Premere i bracci laterali di bloccaggio.

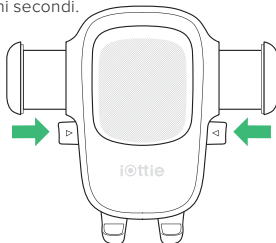

2. Premere il dispositivo contro il pulsante di attivazione Easy One Touch. I bracci del supporto chiuderanno automaticamente al contatto e terranno il dispositivo durante il viaggio.

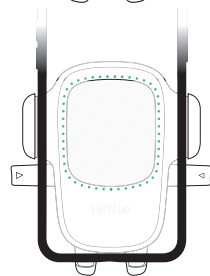

Il Rilascio

Premere i bracci laterali di bloccaggio con una mano e recuperare il dispositivo.

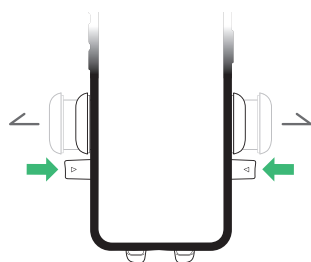

Regolazione del Supporto



1. Manopola della base

Per montare in modalità orizzontale, allentare per ruotare la base. Stringere per bloccare nella posizione desiderata.

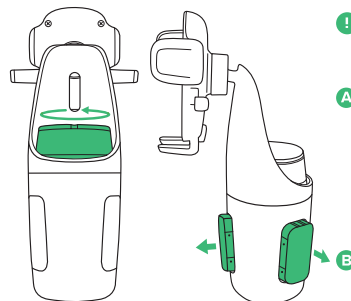

3. Quadrante a rotazione

Ruotare il quadrante per garantire che i distanziatori siano fissati nelle pareti del portabevande.

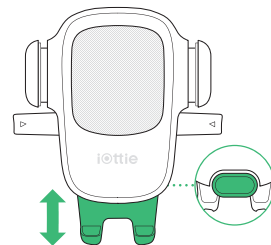

2. Pulsante a pedale

Situato sul retro del supporto. Premere il pulsante per riposizionare i supporti del pedale. Il pedale può essere regolato in alto e in basso per adattarsi a tutte le dimensioni del telefono.

! Organizzatore di cavi magnetici per mantenere il cavo organizzato e fuori mano.

A

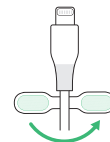

B

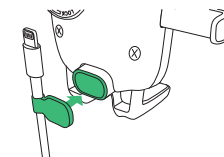

Erste Schritte

Befolgen Sie für eine optimale Montage die detaillierten Anweisungen in diesem Handbuch bei Verwendung des Easy One Touch 5. iOttie haftet nicht für mögliche Schäden aufgrund von Produktmissbrauch.

Kritische Information

- Die Halterung sollte so ausgerichtet sein, dass alle 3 Abstandshalter die Innenwand des Getränkehalters berühren.
- Drehen Sie das Ziffernblatt, um die Abstandshalter so zu verlängern, dass sie die Innenwände des Getränkehalters sicher berühren.

Specifications

ARTIKEL	SPEZIFIKATIONEN
TIEFE	8.6 cm
BREITE	7 cm
HÖHE	18.3 cm
GEWICHT	198 g

- ! Die obere Hälfte der Halterung lässt sich für eine optimale Anzeige um 90 Grad drehen.
- ! Die Halterung lässt sich für optimale Betrachtungswinkel um 360° drehen.

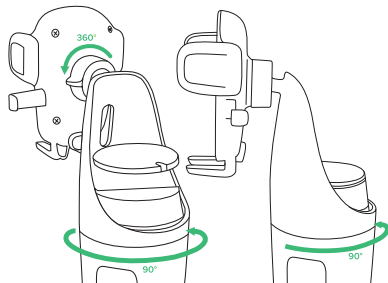

Auf einen Blick

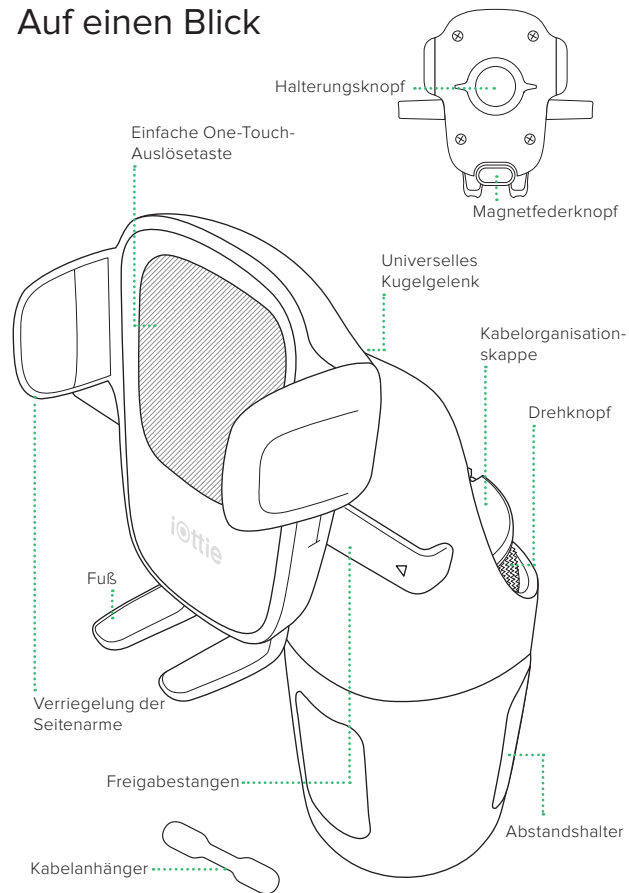

Verwenden von Easy-One-Touch-Mechanismus

Mit dem Easy-One-Touch-Verriegelungs- und Freigabemechanismus können Sie Ihr Smartphone in Sekundenschnelle montieren und abholen.

Einbau

1. Drücken Sie die Verriegelungsseitenarme ein.

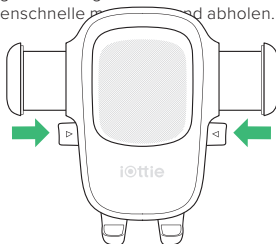

2. Drücken Sie Ihr Gerät gegen die Easy-One-Touch-Auslösetaste. Die Arme der Halterung schließen sich bei Berührung automatisch und halten das Gerät während der Fahrt.

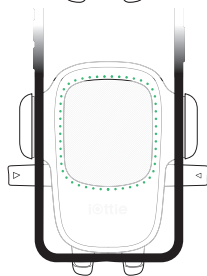

Freigabe

Drücken Sie die Verriegelungsseitenarme mit einer Hand und holen Sie das Gerät ab.

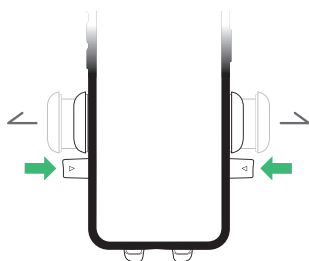

Einstellung der Halterung

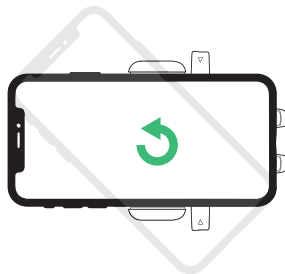

1. Wiegeknopf

Wenn Sie im Querformat montieren, lösen Sie die Wiege, um sie zu drehen. Ziehen Sie sie fest, um die gewünschte Position festzulegen.

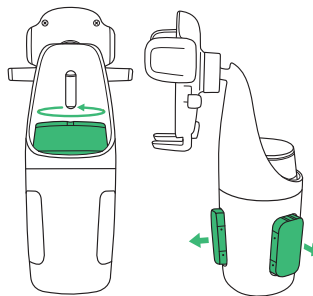

3. Drehknopf

Drehen Sie das Ziffernblatt, um sicherzustellen, dass die Abstandshalter sicher in den Wänden des Getränkehalters sitzen.

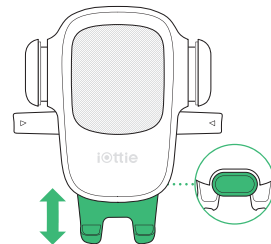

2. Fuß-Taste

Befindet sich auf der Rückseite der Halterung. Drücken Sie den Knopf, um den Fuß der Halterung neu zu positionieren. Der Fuß kann nach oben und unten verstellt werden, damit er für jede Telefongröße passt.

! Magnetischer Kabelhalter, damit das Kabel organisiert und nicht im Weg ist.

A

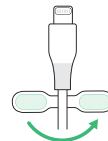

B

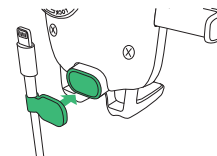

Empezando

Para un montaje óptimo, siga las instrucciones detalladas en este manual cuando utilice el Easy One Touch 5. ¡Ottie no se hace responsable de posibles daños debido al uso incorrecto del producto.

Información crucial

- El soporte debe estar alineado de manera que los 3 espaciadores entren en contacto con la pared interna del sujetador.
- el dial para extender los espaciadores para que entren en contacto de manera segura con las paredes internas del sujetador.

Specifications

ARTICULO	ESPECIFICACIONES
PROFUNDIDAD	8.6 cm
ANCHO	7 cm
ALTURA	18.3 cm
PESO	198 g

- ! La mitad superior del soporte gira 90° para lograr una visualización óptima.
- ! El soporte gira 360° para obtener ángulos de visión óptimos.

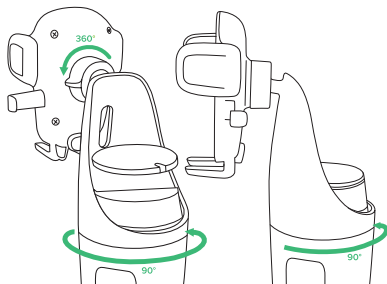

De un vistazo

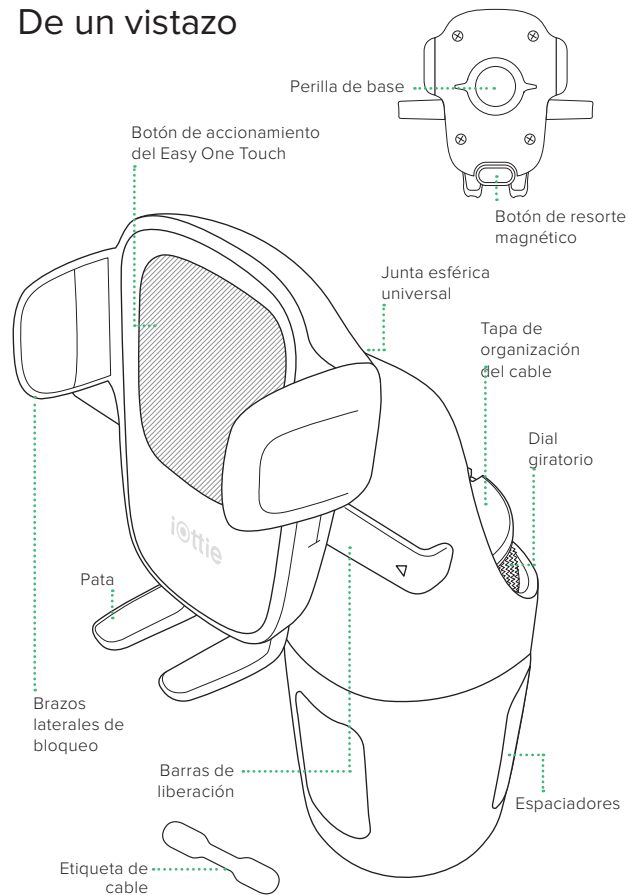

Uso del mecanismo Easy One Touch

Colocación

1. Presione los brazos de bloqueo.

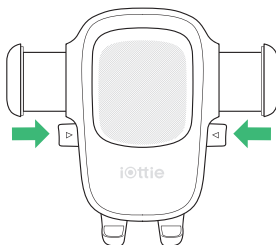

2. Presione su dispositivo contra el botón de activación del Easy One Touch. Los brazos de la montura se cerrarán automáticamente al entrar en contacto y sujetarán el dispositivo durante el viaje.

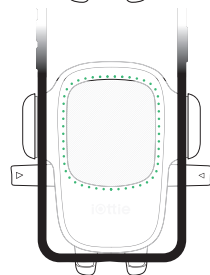

Retirar

Presione los brazos de bloqueo con una mano y retire el dispositivo.

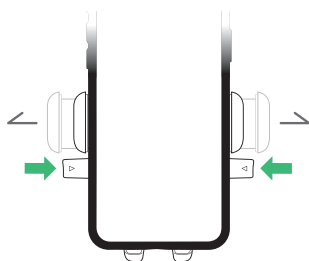

Ajuste del soporte



1. Perilla de la horquilla

Cuando lo instale en modo horizontal, afloje la perilla para girar la horquilla. Apriétela para fijarla en la posición deseada.

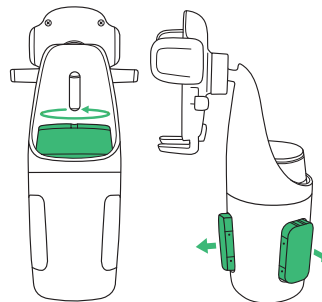

3. Dial giratorio

Gire el dial para asegurarse de que los espaciadores estén fijados a las paredes del sujetador.

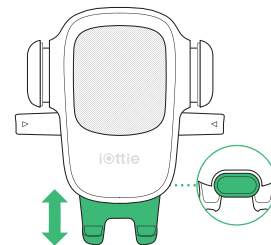

2. Botón de liberación del pie

Ubicado en la parte trasera de la montura. Presione el botón para volver a colocar el pie de montaje.

! Organizador de cable magnético mantiene los cables organizados.

A

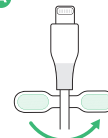

B

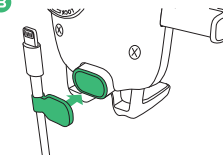



EN If you love your iOttie product, let us know by leaving a review online, or connect with us on our social platforms.

FR Si vous aimez votre produit iOttie, merci de nous le faire savoir en laissant un commentaire en ligne ou nous rejoindre sur nos réseaux sociaux.

IT Se ami il tuo prodotto iOttie, faccelo sapere lasciando una recensione online o sulle nostre piattaforme social.

DE Wenn Sie von Ihrem iOttie-Produkt begeistert sind, lassen Sie es uns bitte wissen, indem Sie eine Bewertung online abgeben oder sich mit uns auf unseren sozialen Plattformen verbinden.

ES Si le gusta su producto iOttie, háganos saber dejando una reseña en línea, o conéctese con nosotros en nuestras plataformas sociales.

Hiermit erklärt iOttie, dass sich diese in Übereinstimmung mit den grundlegenden Anforderungen und den übrigen einschlägigen Bestimmungen der Richtlinie 2014/53/EU befindet. Die EG-Konformitätserklärung kann hier heruntergeladen werden: <https://www.iottie.com/support/doc>*

iottie



20 W 37th St
New York, NY 10018
U.S.A.

 www.iottie.com

 cs@iottie.com